

## 005470 | SMARTSTATION® SET

UNDERMOUNT STAINLESS STEEL KITCHEN SINK AND ACCESSORIES

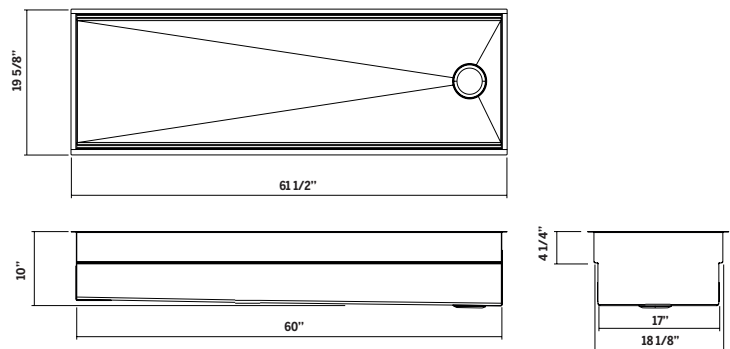

### Specifications

Model	005470
Collection	SmartStation®
Bowl dimensions	60" x 18 1/8" x 10"
Overall dimensions	61 1/2" x 19 5/8" x 10"
Recommended cabinet	Custom Cabinet
Accessories handle material	Walnut

### Included accessories

Grid	200928 - 200927
Cutting board	210067
Serving bin with bowls (4)	225215
Serving board with bowl and colander	225208
Drying rack	215207
Tray	205234

### Recommended accessories

Drain	100082
Colander	205225
Service bowls	225203
And many more	

### Warranty

Home Refinements offers a LIMITED LIFETIME WARRANTY on the fixed components of its stainless steel sinks against defects of material and workmanship as well as a 1-YEAR LIMITED WARRANTY following the purchase date for all accessories against defects of material and workmanship. This warranty is limited to defects or damages resulting from a normal residential use. For further details on our product warranty, please refer to our catalog or Web site.

### Features

- Handcrafted in Canada
- Commercial quality stainless steel 16 ga thickness
- Corrosion resistant material 304 series (18/10)
- Unique design allowing the Home Refinements standard accessories to slide one over the other on two levels
- 1/2" accessory ledge on front and back of the bowl to accommodate any standard 17" Home Refinements accessory
- Standard 18" Home Refinements accessories to be used directly on the countertop (undermount with overhang countertop installation necessary)
- Many accessories included depending on the width of the sink to be used on accessory ledge or on the countertop (two (2) wood essences available: maple and american walnut)
- Bottom grid included to protect the surface of the sink
- Attractive combination of UrbanEdge® and J7® collections : vertical square corners [0mm] and slightly rounded corners [7mm] for bottom front and back folds
- Environmentally friendly product, 100% recyclable
- Elegant no. 4 brushed finish that matches the appliances
- Highly efficient sound deadening pads
- Practical flat sink bottom and straight bowl sides that maximize available space in the bowl
- Stylish and functional bowl bottom grooves that facilitate water drainage
- Rear or side 3-1/2" drain placement
- Mounting hardware included
- Certifications: ASME A112.19.3, CSA B45.0, CSA B45.4