

GRAB BARS SERIES PERSONAL GRAB BAR

8289503

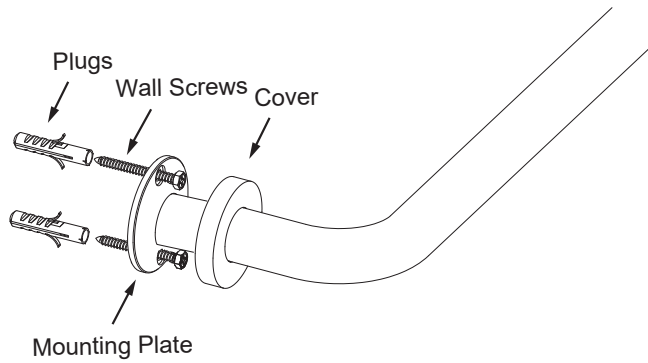

Tools required for installation

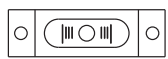

Level



Pencil



Wrench

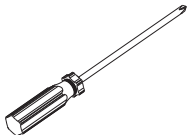

Screwdriver

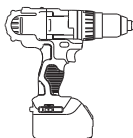

Drill



Hammer

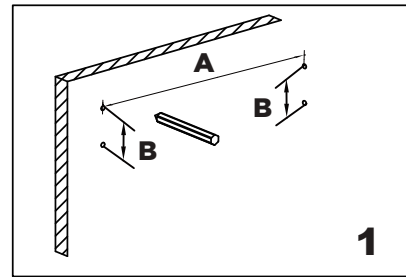

Mark (on the wall) locations of plugs through mounting plate using a pencil, refer to Fig.1

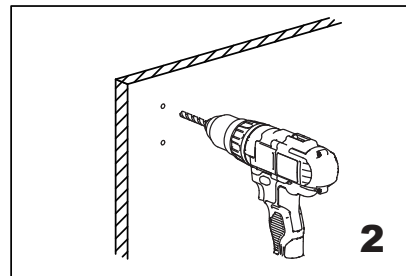

Drill 3/16" holes, make sure to keep drill level

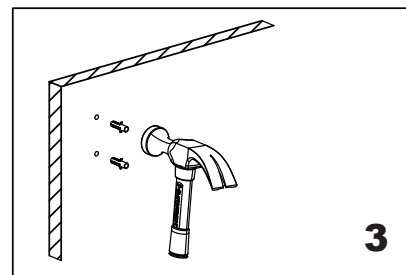

Insert plugs into drilled holes, using a hammer to tap the plugs in, be careful not to break tile

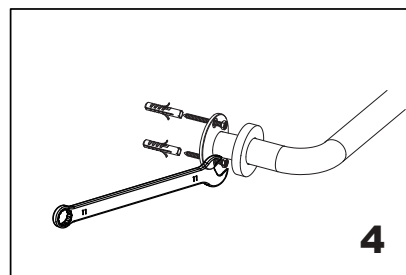

Driver bolt nut directly into holes

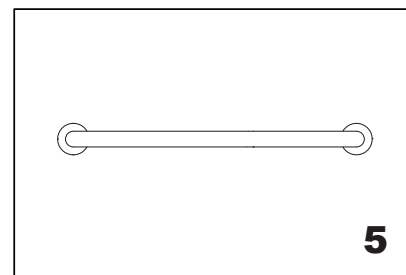

Tighten the cover on the Mounting plate