



C081 SS

RECTANGULAR BAR SINK WITH DECORATIVE GRATE

DETAILS

Installation Type: Drop-In or Undermount

Sink Materials: Stainless Steel

Handcrafted Smooth Metal

Standard 1.5" Drain, No Overflow

Each sink is hand-crafted; no two sinks will be the same



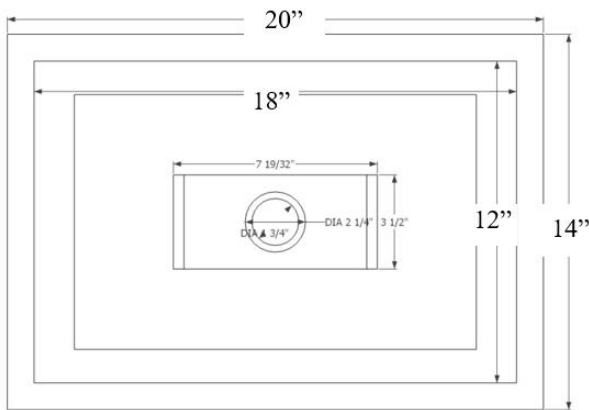

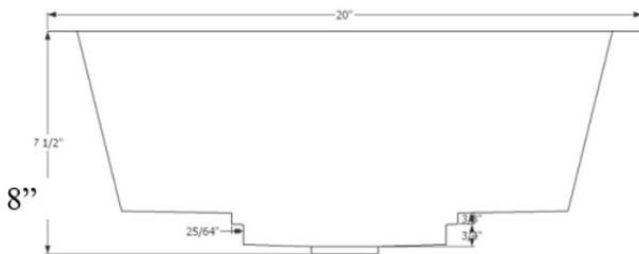

NOTE: Due to the handmade nature of the sink variations in the metal may be visible.







[Dimensions are approximate]



AVAILABLE GRATES





	GM001	Filigree
	GM002	Leaves
	GM003	Spoke
	GM004	Hawaiian Quilt
	GM007	Square Bars
	GM008	Deco

AVAILABLE FINISHES

	PB	Polished Unlacquered Brass
	UB	Satin Unlacquered Brass
	PS	Polished Stainless Steel
	SS	Satin Stainless Steel

*Grates are not sold as a stand-alone item, should be ordered at the same time as the sink.

AVAILABLE DRAINS

	D004	Grid Strainer
	D005	Lift & Turn
	D006	Pop-up w/ lift rod
	D011-D017	Decorative Grid Strainers
	D101-D720	Decorative Drains

INSTALLATION

Drain should be installed first.

DROP-IN: Cut opening large enough for the sink to be "dropped in" to countertop.

UNDERMOUNT: Cuts in countertop are up to the discretion of the installer. Clips or other installation method must be provided by the fabricator/installer. Use 100% silicone to adhere sink to countertop. Clean any excess silicone from sink surface to avoid damaging the finish.

CARE

This sink has a living finish which will change with time and use. Use mild soap and water for everyday cleaning. Avoid any harsh abrasives, acidic cleaning products and antibacterial hand soap. A paste wax may be applied periodically to protect the finish and help with water spotting.

WARRANTY

Linkasink warranties our product to be free from manufacturing defect for the life of the product. Warranty does not cover improper care or abuse/neglect, or changes to the living finish.

DIMENSIONS WILL VARY

DO NOT use this sheet as a guide for countertop cuts. Due to the handmade nature of each product, templates are not provided.